



SPECIFICATIONS:

CONTACT RATING: 0.5A /220VAC.
 MECHANICAL LIFE: 1,000,000 cycles Min.
 ELECTRICAL LIFE: 50,000cycles Min.
 CONTACT RESISTANCE: 50m-ohms Max.
 INSULATION RESISTANCE: 100M-ohms Min.(500VDC)
 DIELECTRIC STRENGTH: 1,500V, RMS 50Hz, 1min.
 OPERATING TEMPERATURE: -25°C~+55°C(No Freezing).
 IP CLASS: IP40/IP65;IK07.
 TORQUE: 0.6Nm max. applied to nut.

MATERIALS:

BODY & BUTTON: See Option.
 CONTACT: Silver alloy.
 BASE: PA.

Specifications and Dimensions subject to change

If your preferred product configuration is not shown, please contact our sales representative for custom design.

HOW TO ORDER SYSTEM

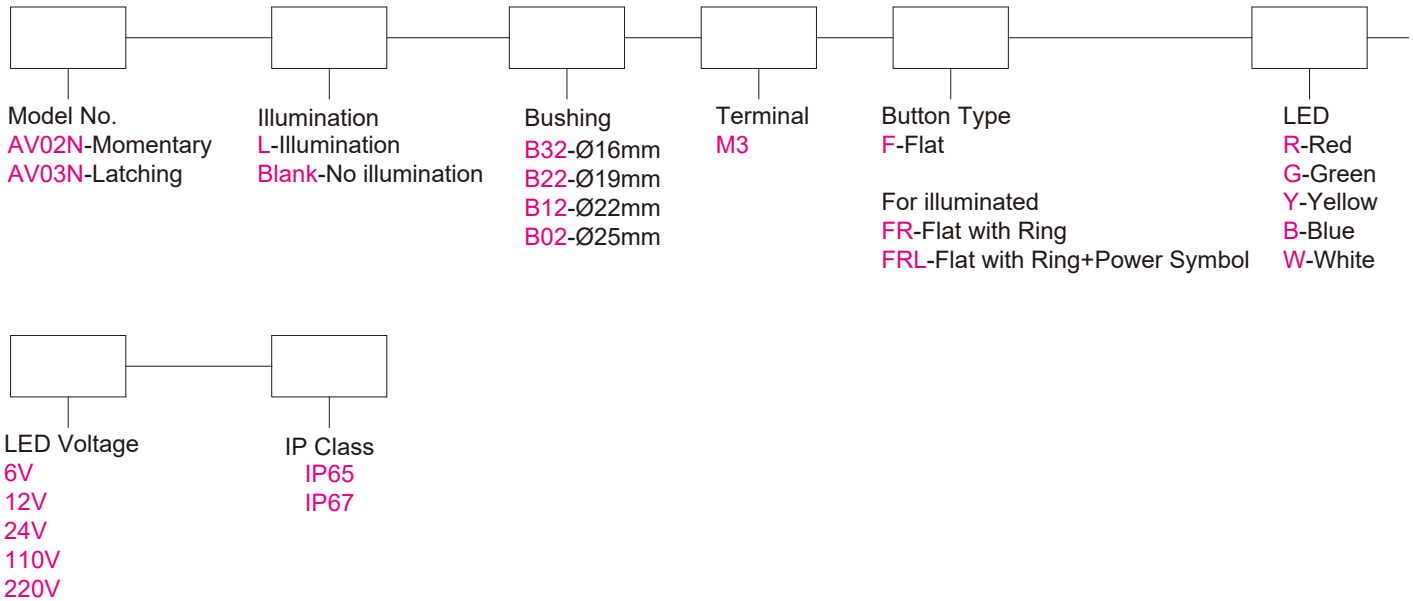

Non-latching & Latching Ø16mm, Quick Connect

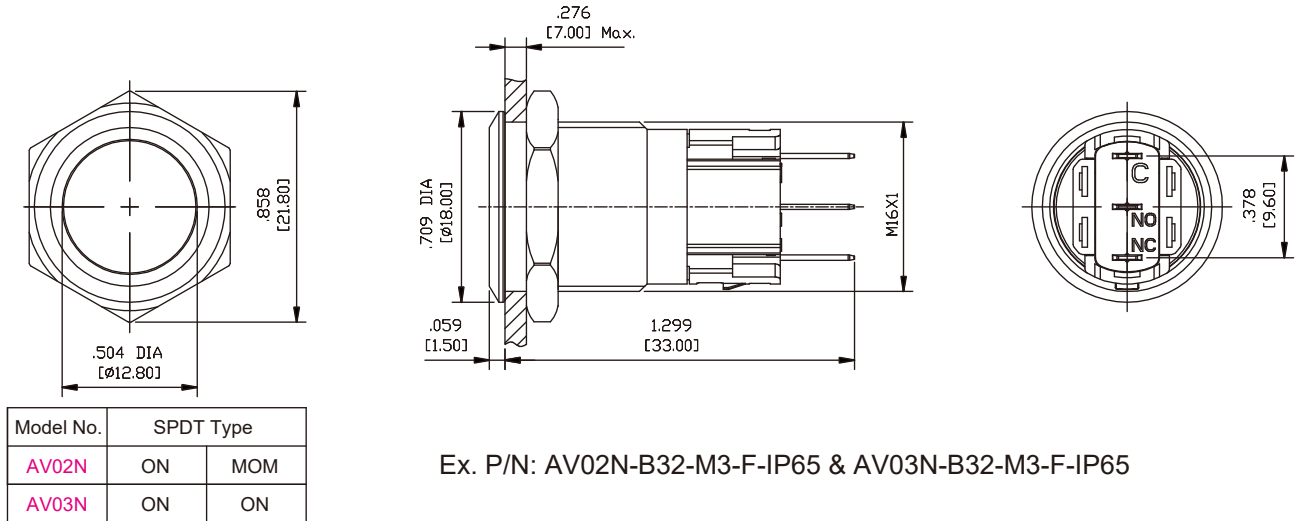

Ex. P/N: AV02N-B32-M3-F-IP65 & AV03N-B32-M3-F-IP65

Non-latching & Latching Ø19mm, Quick Connect

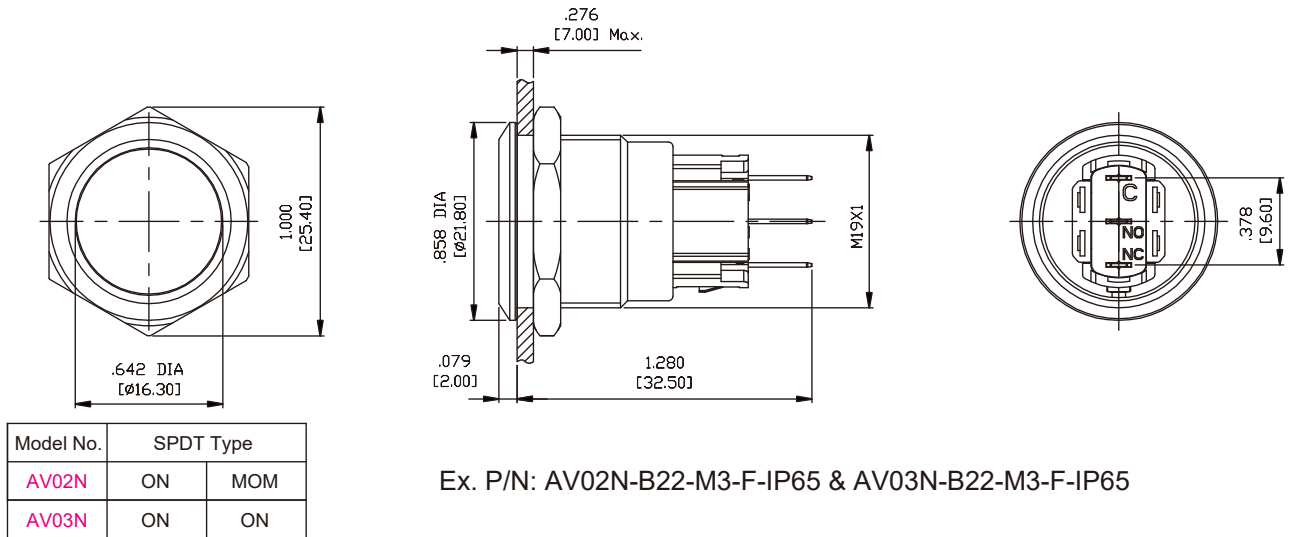

Ex. P/N: AV02N-B22-M3-F-IP65 & AV03N-B22-M3-F-IP65

Non-latching & Latching Ø22mm, Quick Connect

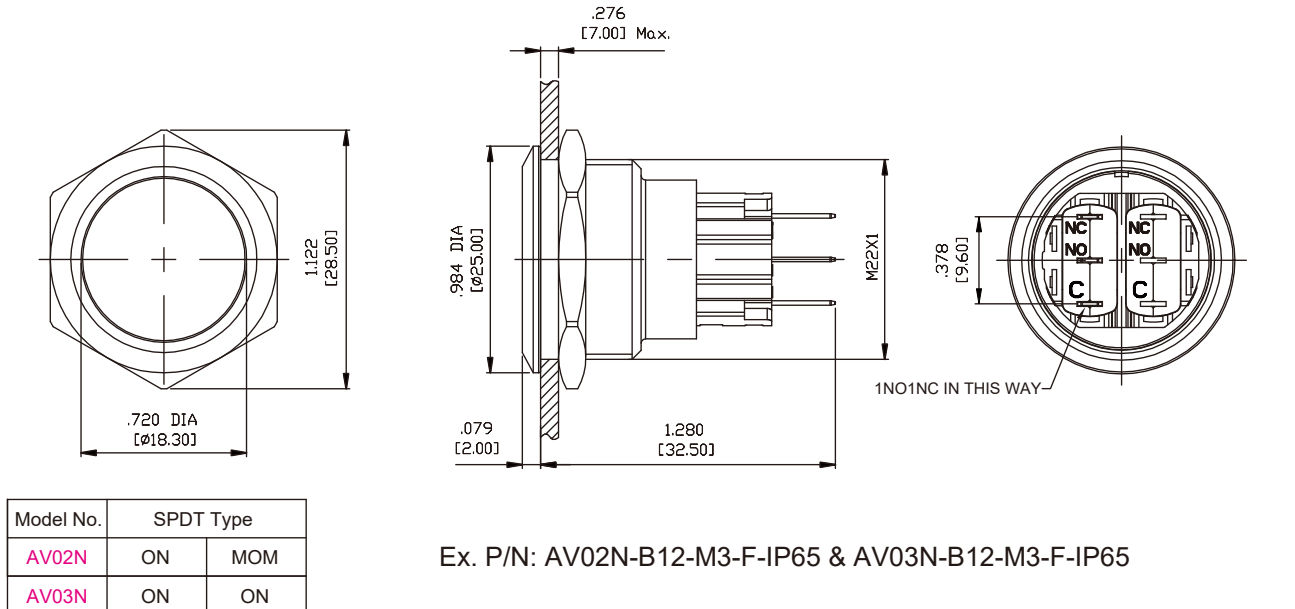

Ex. P/N: AV02N-B12-M3-F-IP65 & AV03N-B12-M3-F-IP65

Series AV02N(L)/AV03N(L)

Anti-Vandal Pushbutton Switches

Non-latching & Latching Ø25mm, Quick Connect

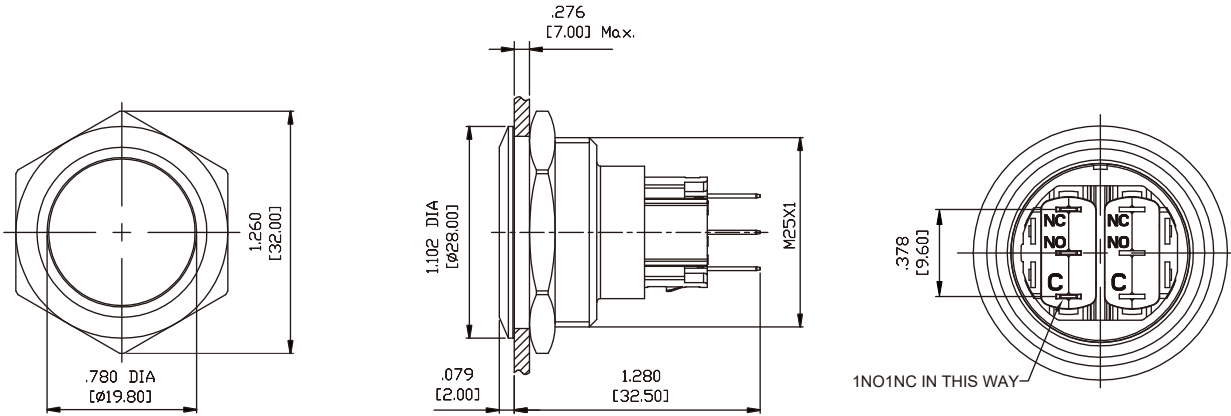

Model No.	SPDT Type	
AV02N	ON	MOM
AV03N	ON	ON

P/N: AV02N-B02-M3-F-IP65 & AV03N-B02-M3-F-IP65

Illuminated Non-latching & Latching Ø16mm, Quick Connect

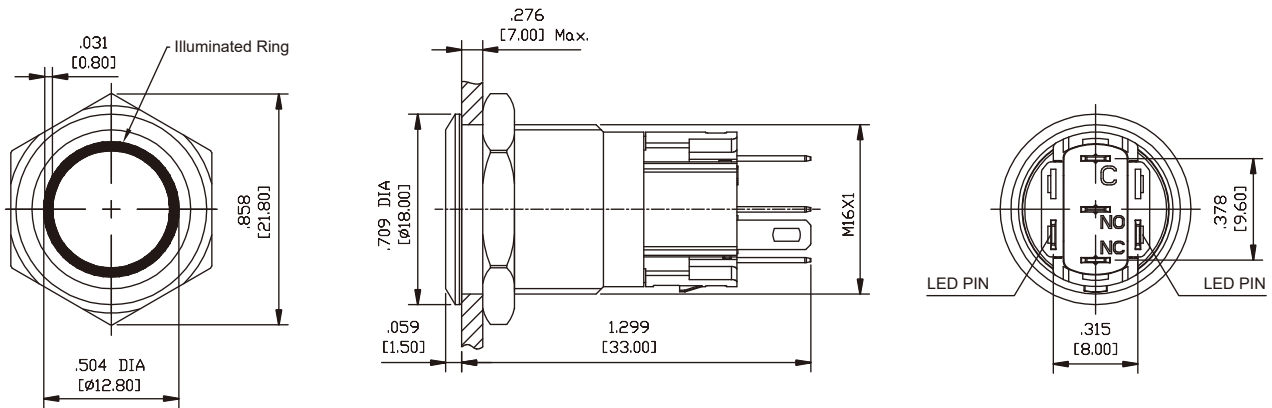

P/N: AV02(03)NL-B32-M3-FR-x-y-IP65 ("x"=LED Color,"y"=LED Voltage)

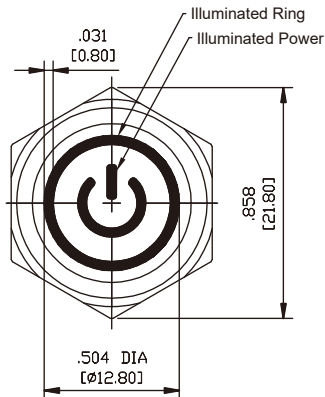

Model No.	SPDT Type	
AV02NL	ON	MOM
AV03NL	ON	ON

P/N: AV02(03)NL-B32-M3-FRL-x-y-1-IP65 ("x"=LED Color,"y"=LED Voltage)

Illuminated Non-latching & Latching Ø19mm, Quick Connect

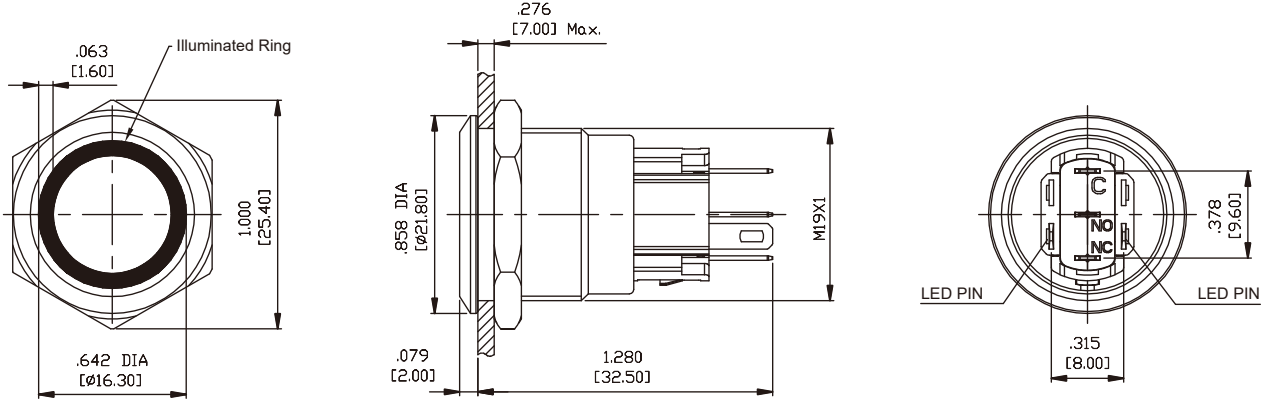

P/N: AV02(03)NL-B22-M3-FR-x-y-IP65 ("x"=LED Color,"y"=LED Voltage)

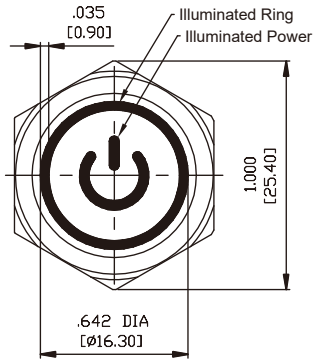

Model No.	SPDT Type	
AV02NL	ON	MOM
AV03NL	ON	ON

P/N: AV02(03)NL-B22-M3-FRL-x-y-1-IP65 ("x"=LED Color,"y"=LED Voltage)

Illuminated Non-latching & Latching Ø22mm, Quick Connect

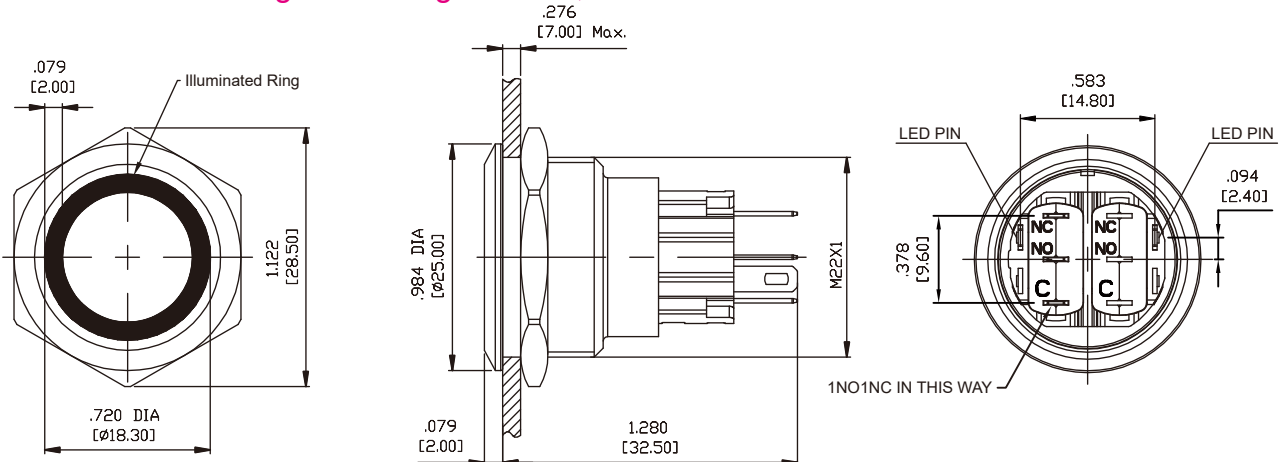

P/N: AV02(03)NL-B12-M3-FR-x-y-IP65 ("x"=LED Color,"y"=LED Voltage)

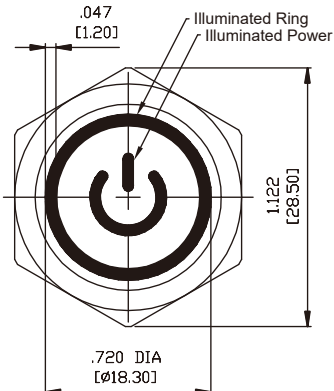

Model No.	SPDT Type	
AV02NL	ON	MOM
AV03NL	ON	ON

P/N: AV02(03)NL-B12-M3-FRL-x-y-1-IP65 ("x"=LED Color,"y"=LED Voltage)

Illuminated Non-latching & Latching Ø25mm, Quick Connect

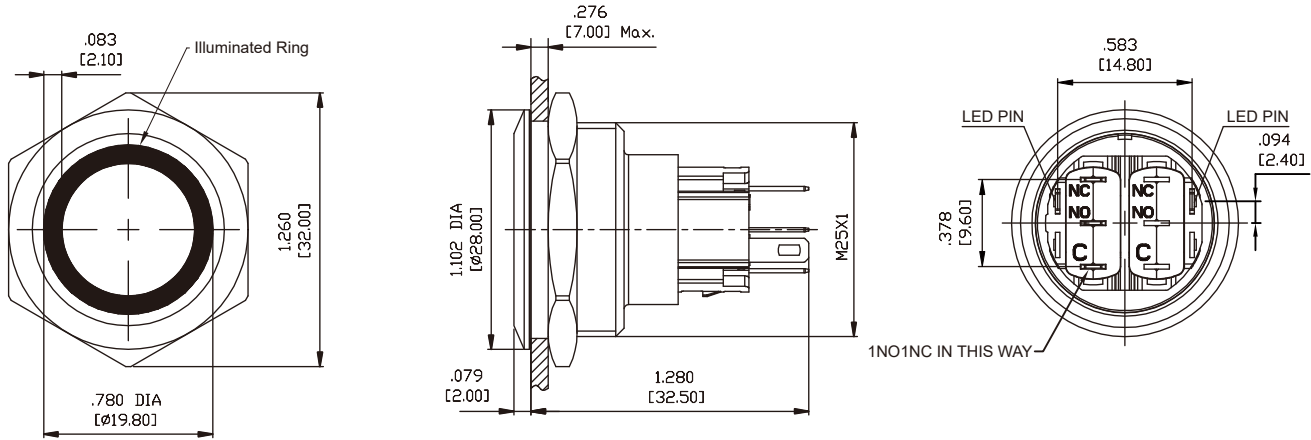

P/N: AV02(03)NL-B02-M3-FR-x-y-IP65 ("x"=LED Color,"y"=LED Voltage)

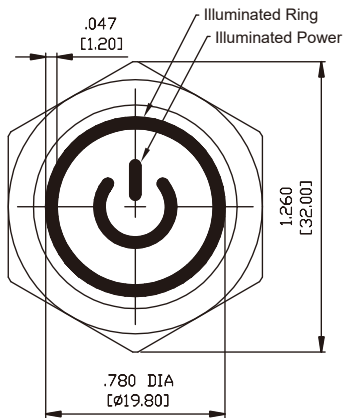

Model No.	SPDT Type	
AV02NL	ON	MOM
AV03NL	ON	ON

P/N: AV02(03)NL-B02-M3-FRL-x-y-1-IP65 ("x"=LED Color,"y"=LED Voltage)

BUSHING & BUTTON MATERIAL OPTIONS

Code	Bushing Size	Bushing & Button Material
B02,B12,B22,B32	Ø25,22,19,16mm	Stainless steel

LED COLOR & VOLTAGE OPTIONS

Code	Button Color	Code	LED Voltage and Consumption
R	Red	6V	6V (AC/DC Compatible)
G	Green	12V	12V (AC/DC Compatible)
Y	Yellow	24V	24V (AC/DC Compatible)
B	Blue	110V	110V (AC/DC Compatible)
W	White	220V	220V (AC/DC Compatible)